

CD4009UB, CD4010B Types

CMOS Hex Buffers/Converters

High-Voltage Types (20-Volt Rating)

Inverting Type: CD4009UB

Non-Inverting Type: CD4010B

■ CD4009UB and CD4010B Hex Buffer/Converters may be used as CMOS to TTL or DTL logic-level converters or CMOS high-sink-current drivers.

The CD4049UB and CD4050B are preferred hex buffer replacements for the CD4009UB and CD4010B, respectively, in all applications except multiplexers. For applications not requiring high sink current or voltage conversion, the CD4069UB Hex Inverter is recommended.

The CD4009UB and CD4010B types are supplied in 16-lead hermetic dual-in-line ceramic packages (F3A suffix), 16-lead dual-in-line plastic packages (E suffix), 16-lead small-outline packages (M, M96, MT, and NSR suffixes), and 16-lead thin shink small-outline packages (PW and PWR suffixes).

Features:

- 100% tested for quiescent current at 20 V
- Maximum input current of 1 μ A at 18 V over full package-temperature range; 100 nA at 18 V and 25°C
- 5-V, 10-V, and 15-V parametric ratings

Applications:

- CMOS to DTL/TTL hex converter
- CMOS current “sink” or “source” driver
- CMOS high-to-low logic-level converter
- Multiplexer — 1 to 6 or 6 to 1

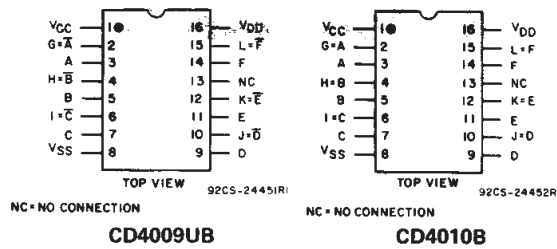

TERMINAL ASSIGNMENTS

MAXIMUM RATINGS, Absolute-Maximum Values:

DC SUPPLY-VOLTAGE RANGE, (V_{DD})

Voltages referenced to V_{SS} Terminal) -0.5V to +20V

INPUT VOLTAGE RANGE, ALL INPUTS -0.5V to V_{DD} +0.5V

DC INPUT CURRENT, ANY ONE INPUT \pm 10mA

POWER DISSIPATION PER PACKAGE (P_D):

For T_A = -55°C to +100°C 500mW

For T_A = +100°C to +125°C Derate Linearly at 12mW/°C to 200mW

DEVICE DISSIPATION PER OUTPUT TRANSISTOR

FOR T_A = FULL PACKAGE-TEMPERATURE RANGE (All Package Types) 100mW

OPERATING-TEMPERATURE RANGE (T_A) -55°C to +125°C

STORAGE TEMPERATURE RANGE (T_{stg}) -65°C to +150°C

LEAD TEMPERATURE (DURING SOLDERING):

At distance 1/16 \pm 1/32 inch (1.59 \pm 0.79mm) from case for 10s max +265°C

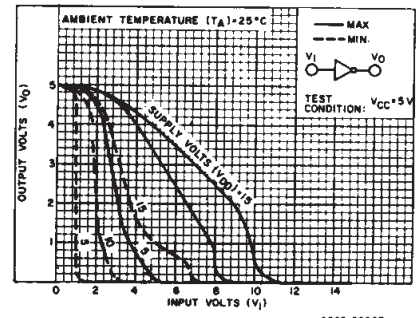
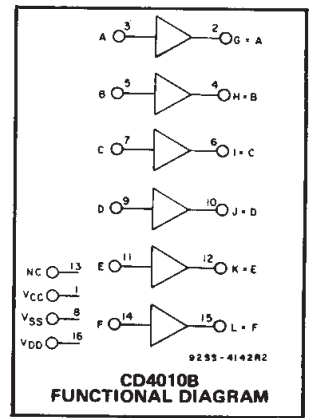
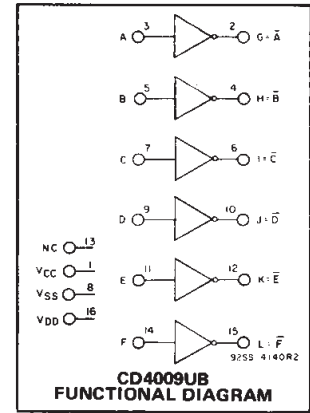

Fig. 3 – Minimum and maximum voltage transfer characteristics—CD4009UB.

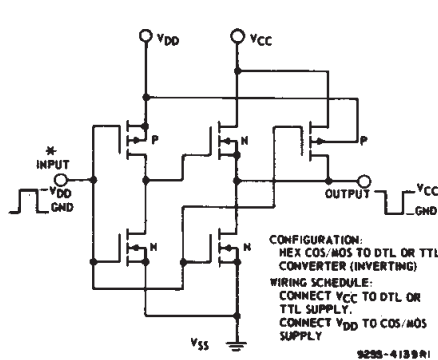

Fig. 1 – Schematic diagram of CD4009UB—1 of 6 identical stages.

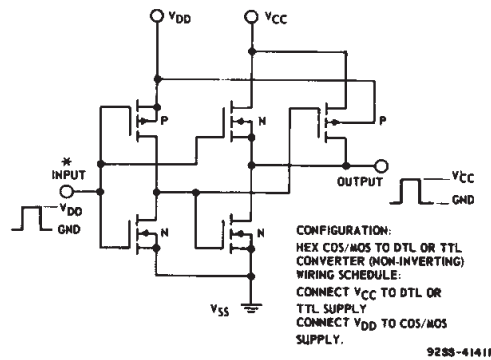
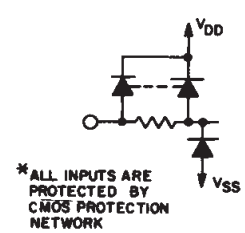

Fig. 2 – Schematic diagram of CD4010B—1 of 6 identical stages.



CD4009UB, CD4010B Types

RECOMMENDED OPERATING CONDITIONS

For maximum reliability, nominal operating conditions should be selected so that operation is always within the following ranges:

CHARACTERISTIC	LIMITS		UNITS
	MIN.	MAX.	
Supply-Voltage Range (For T_A = Full Package Temperature Range), V_{DD}	3	18	V
V_{CC}^*	3	V_{DD}	
Input Voltage Range (V_I)	V_{CC}^*	V_{DD}	V

*The CD4009UB and CD4010B have high-to-low level voltage conversion capability but not low-to-high level, therefore it is recommended that $V_{DD} \geq V_I \geq V_{CC}$.

STATIC ELECTRICAL CHARACTERISTICS

CHARACTERISTIC	CONDITIONS			LIMITS AT INDICATED TEMPERATURES (°C)							UNITS
	V_O (V)	V_{IN} (V)	V_{DD} (V)	-55	-40	+85	+125	+25			
								Min.	Typ.	Max.	
Quiescent Device Current, I_{DD} Max.	-	0.5	5	1	1	30	30	-	0.02	1	μA
	-	0.10	10	2	2	60	60	-	0.02	2	
	-	0.15	15	4	4	120	120	-	0.02	4	
	-	0.20	20	20	20	600	600	-	0.04	20	
Output Low (Sink) Current I_{OL} Min.	0.4	0.5	4.5	3.2	3.1	2.1	1.8	2.6	3.4	-	mA
	0.4	0.5	5	3.75	3.6	2.4	2.1	3	4	-	
	0.5	0.10	10	10	9.6	6.4	5.6	8	10	-	
	1.5	0.15	15	30	40	19	16	24	36	-	
Output High (Source) Current I_{OH} Min.	4.6	0.5	5	-0.25	-0.23	-0.18	-0.15	-0.2	-0.4	-	mA
	2.5	0.5	5	-1	-0.9	-0.65	-0.58	-0.8	-1.6	-	
	9.5	0.10	10	-0.55	-0.5	-0.38	-0.33	-0.45	-0.9	-	
	13.5	0.15	15	-1.65	-1.6	-1.25	-1.1	-1.5	-3	-	
Output Voltage: Low-Level, V_{OL} Max.	-	0.5	5	0.05				-	0	0.05	V
	-	0.10	10	0.05				-	0	0.05	
	-	0.15	15	0.05				-	0	0.05	
Output Voltage: High-Level, V_{OH} Min.	-	0.5	5	4.95				4.95	5	-	V
	-	0.10	10	9.95				9.95	10	-	
	-	0.15	15	14.95				14.95	15	-	
Input Low Voltage: V_{IL} Max. CD4009UB	4.5	-	5	1				-	-	1	V
	9	-	10	2				-	-	2	
	13.5	-	15	2.5				-	-	2.5	
Input Low Voltage: V_{IL} Max. CD4010B	0.5	-	5	1.5				-	-	1.5	V
	1	-	10	3				-	-	3	
	1.5	-	15	4				-	-	4	
Input High Voltage: V_{IH} Min. CD4009UB	0.5	-	5	4				4	-	-	V
	1	-	10	8				8	-	-	
	1.5	-	15	12.5				12.5	-	-	
Input High Voltage: V_{IH} Min. CD4010B	4.5	-	5	3.5				3.5	-	-	V
	9	-	10	7				7	-	-	
	13.5	-	15	11				11	-	-	
Input Current, I_{IN} Max.	-	0.18	18	± 0.1	± 0.1	± 1	± 1	-	$\pm 10^{-5}$	± 0.1	μA

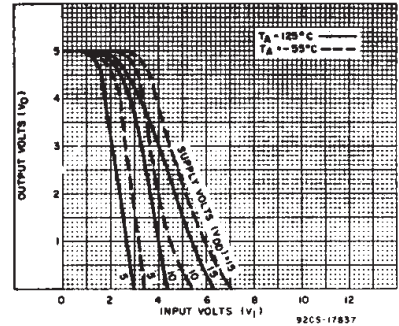

Fig. 4 - Typical voltage transfer characteristics as function of temp. - CD4009UB.

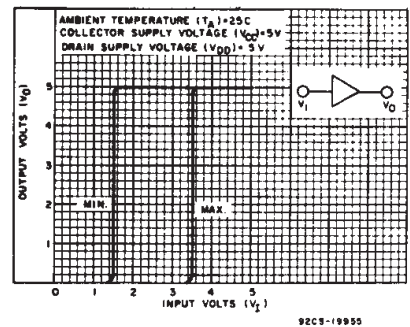

Fig. 5 - Minimum and maximum voltage transfer characteristics ($V_{DD}=5$) - CD4010B.

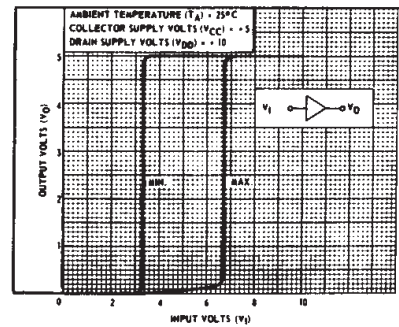

Fig. 6 - Minimum and maximum voltage transfer characteristics ($V_{DD}=10$) - CD4010B.

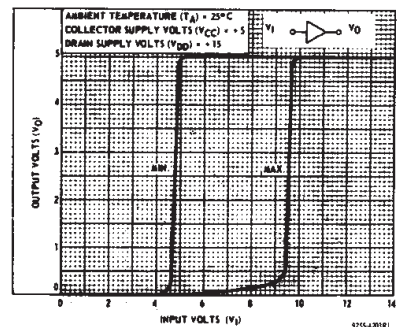

Fig. 7 - Minimum and maximum voltage transfer characteristics ($V_{DD}=15$) - CD4010B.

3
COMMERCIAL CMOS
HIGH VOLTAGE ICs

CD4009UB, CD4010B Types

DYNAMIC ELECTRICAL CHARACTERISTICS at $T_A=25^\circ\text{C}$; Input $t_r, t_f=20\text{ ns}$, $C_L=50\text{ pF}$, $R_L=200\text{ K}\Omega$

CHARACTERISTIC	CONDITIONS			LIMITS ALL PKGS		UNIT	
	V _{DD} (V)	V _I (V)	V _{CC} (V)	TYP.	MAX.		
Propagation Delay Time: Low-to-High, t _{PLH}	CD4009UB	5	5	5	70	140	ns
		10	10	10	40	80	
		10	10	5	35	70	
		15	15	15	30	60	
	CD4010B	5	5	5	100	200	ns
		10	10	10	50	100	
		10	10	5	50	100	
		15	15	15	35	70	
High-to-Low, t _{PHL}	CD4009UB	5	5	5	30	60	ns
		10	10	10	20	40	
		10	10	5	15	30	
		15	15	15	15	30	
	CD4010B	5	5	5	65	130	ns
		10	10	10	35	70	
		10	10	5	30	70	
		15	15	15	25	50	
Transition Time: Low-to-High, t _{TLH}	CD4009UB	5	5	5	150	350	ns
		10	10	10	75	150	
		15	15	15	55	110	
	CD4010B	5	5	5	35	70	ns
		10	10	10	20	40	
		15	15	15	15	30	
Input Capacitance, C _{IN}	CD4009UB	—	—	—	15	22.5	pF
	CD4010B	—	—	—	5	7.5	

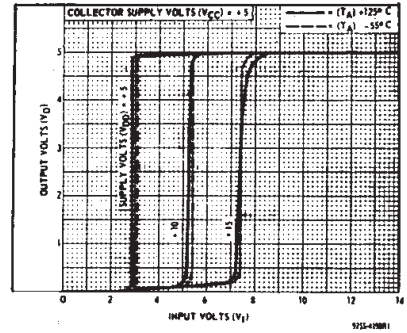

Fig. 8 – Typical voltage transfer characteristics as a function of temperature—CD4010B.

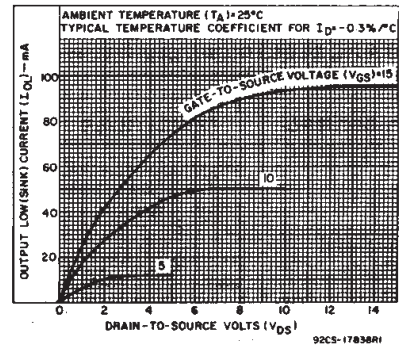

Fig. 9 – Typical output low (sink) current characteristics.

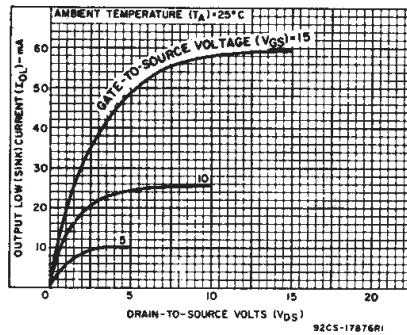

Fig. 10 – Minimum output low (sink) current characteristics.

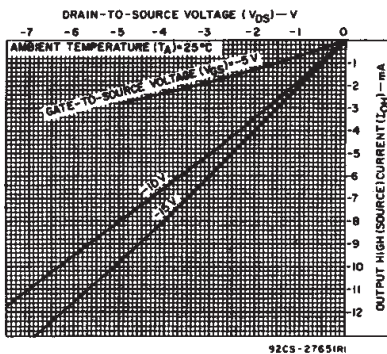

Fig. 11 – Typical output high (source) current characteristics.

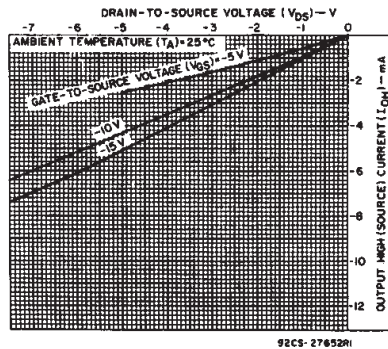

Fig. 12 – Minimum output high (source) current characteristics.

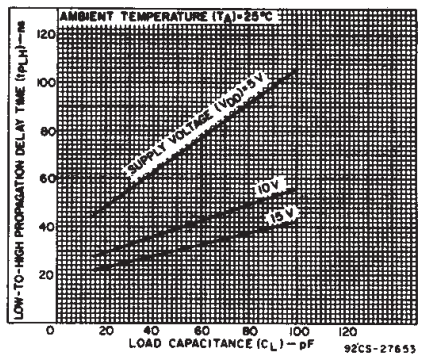

Fig. 13 – Typical low-to-high propagation delay time vs. load capacitance (CD4009UB).

CD4009UB, CD4010B Types

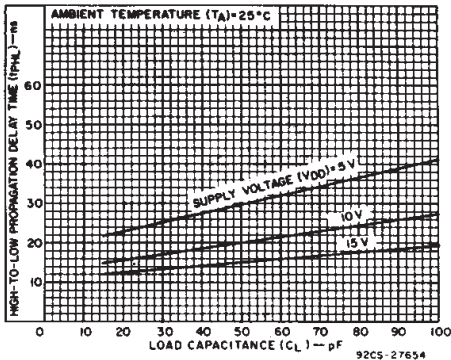

Fig. 14 - Typical high-to-low propagation delay time vs. load capacitance (CD4009UB).

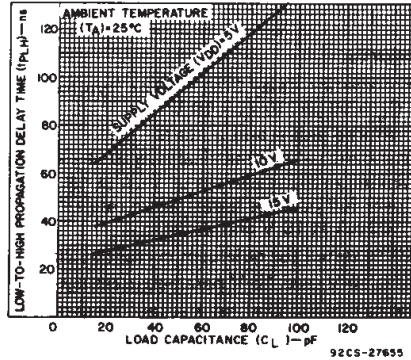

Fig. 15 - Typical low-to-high propagation delay time vs. load capacitance (CD4010B).

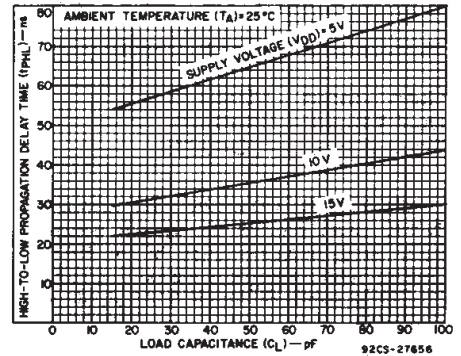

Fig. 16 - Typical high-to-low propagation delay time vs. load capacitance (CD4010B).

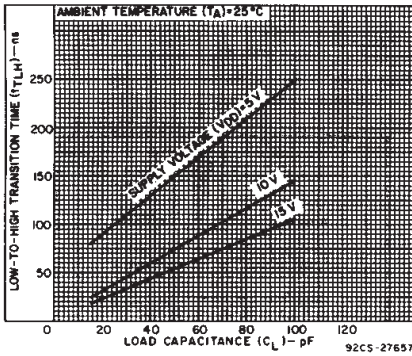

Fig. 17 - Typical low-to-high transition time vs. load capacitance.

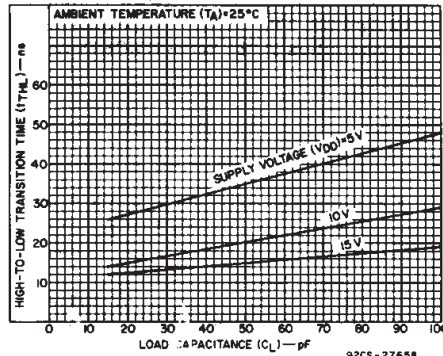

Fig. 18 - Typical high-to-low transition time vs. load capacitance.

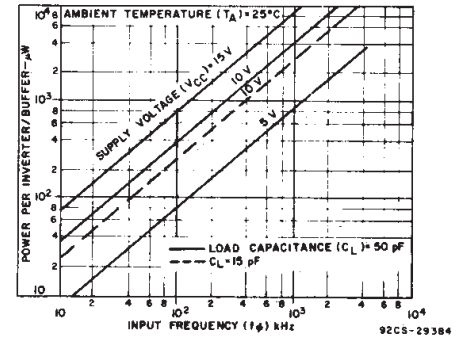

Fig. 19 - Typical dissipation characteristics.

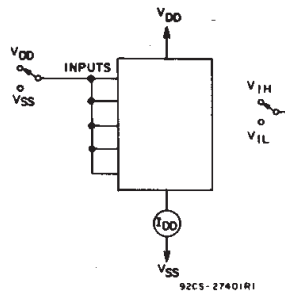

Fig. 20 - Quiescent device current test circuit.

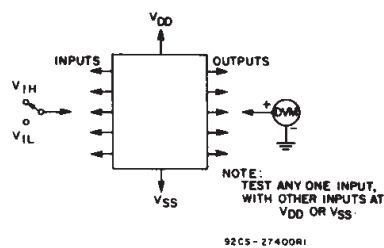

Fig. 21 - Noise immunity test circuit.

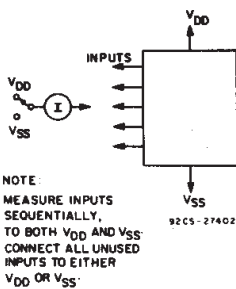
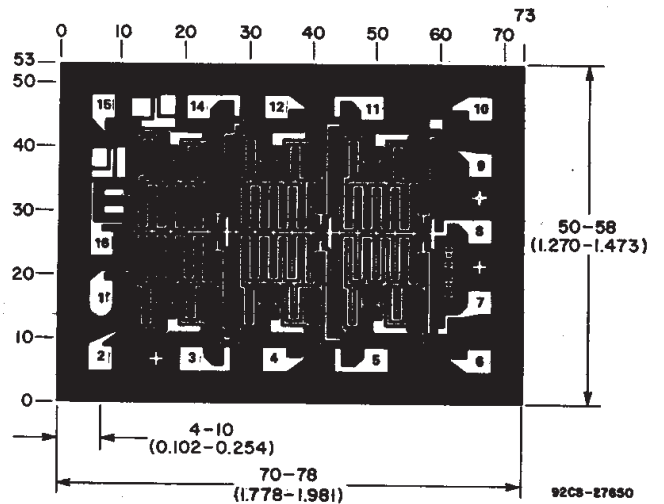

Fig. 22 - Input current test circuit.



Dimensions in parentheses are in millimeters and are derived from the basic inch dimensions as indicated. Grid Graduations Are In Mils (10^{-3} Inch)

Photograph of chip for CD4009UB. Dimensions and pad layout for CD4010B are identical.

3
COMMERCIAL CMOS
HIGH VOLTAGE ICs

PACKAGING INFORMATION

Orderable Device	Status ⁽¹⁾	Package Type	Package Drawing	Pins	Package Qty	Eco Plan ⁽²⁾	Lead/Ball Finish	MSL Peak Temp ⁽³⁾
89264UKB3T	OBSOLETE	CFP	WR	16		TBD	Call TI	Call TI
CD4009UBE	ACTIVE	PDIP	N	16	25	Pb-Free (RoHS)	CU NIPDAU	N / A for Pkg Type
CD4009UBEE4	ACTIVE	PDIP	N	16	25	Pb-Free (RoHS)	CU NIPDAU	N / A for Pkg Type
CD4009UBF	ACTIVE	CDIP	J	16	1	TBD	Call TI	N / A for Pkg Type
CD4009UBF3A	ACTIVE	CDIP	J	16	1	TBD	Call TI	N / A for Pkg Type
CD4009UBM	ACTIVE	SOIC	D	16	40	Green (RoHS & no Sb/Br)	CU NIPDAU	Level-1-260C-UNLIM
CD4009UBM96	ACTIVE	SOIC	D	16	2500	Green (RoHS & no Sb/Br)	CU NIPDAU	Level-1-260C-UNLIM
CD4009UBM96E4	ACTIVE	SOIC	D	16	2500	Green (RoHS & no Sb/Br)	CU NIPDAU	Level-1-260C-UNLIM
CD4009UBME4	ACTIVE	SOIC	D	16	40	Green (RoHS & no Sb/Br)	CU NIPDAU	Level-1-260C-UNLIM
CD4009UBMT	ACTIVE	SOIC	D	16	250	Green (RoHS & no Sb/Br)	CU NIPDAU	Level-1-260C-UNLIM
CD4009UBMTE4	ACTIVE	SOIC	D	16	250	Green (RoHS & no Sb/Br)	CU NIPDAU	Level-1-260C-UNLIM
CD4009UBNSR	ACTIVE	SO	NS	16	2000	Green (RoHS & no Sb/Br)	CU NIPDAU	Level-1-260C-UNLIM
CD4009UBNSRE4	ACTIVE	SO	NS	16	2000	Green (RoHS & no Sb/Br)	CU NIPDAU	Level-1-260C-UNLIM
CD4009UBPW	ACTIVE	TSSOP	PW	16	90	Green (RoHS & no Sb/Br)	CU NIPDAU	Level-1-260C-UNLIM
CD4009UBPWE4	ACTIVE	TSSOP	PW	16	90	Green (RoHS & no Sb/Br)	CU NIPDAU	Level-1-260C-UNLIM
CD4009UBPWR	ACTIVE	TSSOP	PW	16	2000	Green (RoHS & no Sb/Br)	CU NIPDAU	Level-1-260C-UNLIM
CD4009UBPWRE4	ACTIVE	TSSOP	PW	16	2000	Green (RoHS & no Sb/Br)	CU NIPDAU	Level-1-260C-UNLIM
CD4010BE	ACTIVE	PDIP	N	16	25	Pb-Free (RoHS)	CU NIPDAU	N / A for Pkg Type
CD4010BEE4	ACTIVE	PDIP	N	16	25	Pb-Free (RoHS)	CU NIPDAU	N / A for Pkg Type
CD4010BF	ACTIVE	CDIP	J	16	1	TBD	Call TI	N / A for Pkg Type
CD4010BF3A	ACTIVE	CDIP	J	16	1	TBD	Call TI	N / A for Pkg Type
CD4010BM	ACTIVE	SOIC	D	16	40	Green (RoHS & no Sb/Br)	CU NIPDAU	Level-1-260C-UNLIM
CD4010BM96	ACTIVE	SOIC	D	16	2500	Green (RoHS & no Sb/Br)	CU NIPDAU	Level-1-260C-UNLIM
CD4010BM96E4	ACTIVE	SOIC	D	16	2500	Green (RoHS & no Sb/Br)	CU NIPDAU	Level-1-260C-UNLIM
CD4010BME4	ACTIVE	SOIC	D	16	40	Green (RoHS & no Sb/Br)	CU NIPDAU	Level-1-260C-UNLIM
CD4010BMT	ACTIVE	SOIC	D	16	250	Green (RoHS & no Sb/Br)	CU NIPDAU	Level-1-260C-UNLIM
CD4010BMTE4	ACTIVE	SOIC	D	16	250	Green (RoHS & no Sb/Br)	CU NIPDAU	Level-1-260C-UNLIM

Orderable Device	Status ⁽¹⁾	Package Type	Package Drawing	Pins	Package Qty	Eco Plan ⁽²⁾	Lead/Ball Finish	MSL Peak Temp ⁽³⁾
CD4010BNSR	ACTIVE	SO	NS	16	2000	Green (RoHS & no Sb/Br)	CU NIPDAU	Level-1-260C-UNLIM
CD4010BNSRE4	ACTIVE	SO	NS	16	2000	Green (RoHS & no Sb/Br)	CU NIPDAU	Level-1-260C-UNLIM
CD4010BPW	ACTIVE	TSSOP	PW	16	90	Green (RoHS & no Sb/Br)	CU NIPDAU	Level-1-260C-UNLIM
CD4010BPWE4	ACTIVE	TSSOP	PW	16	90	Green (RoHS & no Sb/Br)	CU NIPDAU	Level-1-260C-UNLIM
CD4010BPWR	ACTIVE	TSSOP	PW	16	2000	Green (RoHS & no Sb/Br)	CU NIPDAU	Level-1-260C-UNLIM
CD4010BPWRE4	ACTIVE	TSSOP	PW	16	2000	Green (RoHS & no Sb/Br)	CU NIPDAU	Level-1-260C-UNLIM

⁽¹⁾ The marketing status values are defined as follows:

ACTIVE: Product device recommended for new designs.

LIFEBUY: TI has announced that the device will be discontinued, and a lifetime-buy period is in effect.

NRND: Not recommended for new designs. Device is in production to support existing customers, but TI does not recommend using this part in a new design.

PREVIEW: Device has been announced but is not in production. Samples may or may not be available.

OBSOLETE: TI has discontinued the production of the device.

⁽²⁾ Eco Plan - The planned eco-friendly classification: Pb-Free (RoHS), Pb-Free (RoHS Exempt), or Green (RoHS & no Sb/Br) - please check <http://www.ti.com/productcontent> for the latest availability information and additional product content details.

TBD: The Pb-Free/Green conversion plan has not been defined.

Pb-Free (RoHS): TI's terms "Lead-Free" or "Pb-Free" mean semiconductor products that are compatible with the current RoHS requirements for all 6 substances, including the requirement that lead not exceed 0.1% by weight in homogeneous materials. Where designed to be soldered at high temperatures, TI Pb-Free products are suitable for use in specified lead-free processes.

Pb-Free (RoHS Exempt): This component has a RoHS exemption for either 1) lead-based flip-chip solder bumps used between the die and package, or 2) lead-based die adhesive used between the die and leadframe. The component is otherwise considered Pb-Free (RoHS compatible) as defined above.

Green (RoHS & no Sb/Br): TI defines "Green" to mean Pb-Free (RoHS compatible), and free of Bromine (Br) and Antimony (Sb) based flame retardants (Br or Sb do not exceed 0.1% by weight in homogeneous material)

⁽³⁾ MSL, Peak Temp. -- The Moisture Sensitivity Level rating according to the JEDEC industry standard classifications, and peak solder temperature.

Important Information and Disclaimer:The information provided on this page represents TI's knowledge and belief as of the date that it is provided. TI bases its knowledge and belief on information provided by third parties, and makes no representation or warranty as to the accuracy of such information. Efforts are underway to better integrate information from third parties. TI has taken and continues to take reasonable steps to provide representative and accurate information but may not have conducted destructive testing or chemical analysis on incoming materials and chemicals. TI and TI suppliers consider certain information to be proprietary, and thus CAS numbers and other limited information may not be available for release.

In no event shall TI's liability arising out of such information exceed the total purchase price of the TI part(s) at issue in this document sold by TI to Customer on an annual basis.

J (R-GDIP-T**)

14 LEADS SHOWN

CERAMIC DUAL IN-LINE PACKAGE



DIM \ PINS **	14	16	18	20
A	0.300 (7,62) BSC	0.300 (7,62) BSC	0.300 (7,62) BSC	0.300 (7,62) BSC
B MAX	0.785 (19,94)	.840 (21,34)	0.960 (24,38)	1.060 (26,92)
B MIN	—	—	—	—
C MAX	0.300 (7,62)	0.300 (7,62)	0.310 (7,87)	0.300 (7,62)
C MIN	0.245 (6,22)	0.245 (6,22)	0.220 (5,59)	0.245 (6,22)



4040083/F 03/03

- NOTES:
- All linear dimensions are in inches (millimeters).
 - This drawing is subject to change without notice.
 - This package is hermetically sealed with a ceramic lid using glass frit.
 - Index point is provided on cap for terminal identification only on press ceramic glass frit seal only.
 - Falls within MIL STD 1835 GDIP1-T14, GDIP1-T16, GDIP1-T18 and GDIP1-T20.

N (R-PDIP-T**)

PLASTIC DUAL-IN-LINE PACKAGE

16 PINS SHOWN



- NOTES:
- A. All linear dimensions are in inches (millimeters).
 - B. This drawing is subject to change without notice.
 - $\triangle C$ Falls within JEDEC MS-001, except 18 and 20 pin minimum body length (Dim A).
 - $\triangle D$ The 20 pin end lead shoulder width is a vendor option, either half or full width.

D (R-PDSO-G16)

PLASTIC SMALL-OUTLINE PACKAGE



- NOTES:
- A. All linear dimensions are in inches (millimeters).
 - B. This drawing is subject to change without notice.
 - C. Body dimensions do not include mold flash or protrusion not to exceed 0.006 (0,15).
 - D. Falls within JEDEC MS-012 variation AC.

MECHANICAL DATA

NS (R-PDSO-G**)

PLASTIC SMALL-OUTLINE PACKAGE

14-PINS SHOWN



- NOTES:
- A. All linear dimensions are in millimeters.
 - B. This drawing is subject to change without notice.
 - C. Body dimensions do not include mold flash or protrusion, not to exceed 0,15.

PW (R-PDSO-G**)

PLASTIC SMALL-OUTLINE PACKAGE

14 PINS SHOWN



4040064/F 01/97

- NOTES: A. All linear dimensions are in millimeters.
 B. This drawing is subject to change without notice.
 C. Body dimensions do not include mold flash or protrusion not to exceed 0,15.
 D. Falls within JEDEC MO-153

IMPORTANT NOTICE

Texas Instruments Incorporated and its subsidiaries (TI) reserve the right to make corrections, modifications, enhancements, improvements, and other changes to its products and services at any time and to discontinue any product or service without notice. Customers should obtain the latest relevant information before placing orders and should verify that such information is current and complete. All products are sold subject to TI's terms and conditions of sale supplied at the time of order acknowledgment.

TI warrants performance of its hardware products to the specifications applicable at the time of sale in accordance with TI's standard warranty. Testing and other quality control techniques are used to the extent TI deems necessary to support this warranty. Except where mandated by government requirements, testing of all parameters of each product is not necessarily performed.

TI assumes no liability for applications assistance or customer product design. Customers are responsible for their products and applications using TI components. To minimize the risks associated with customer products and applications, customers should provide adequate design and operating safeguards.

TI does not warrant or represent that any license, either express or implied, is granted under any TI patent right, copyright, mask work right, or other TI intellectual property right relating to any combination, machine, or process in which TI products or services are used. Information published by TI regarding third-party products or services does not constitute a license from TI to use such products or services or a warranty or endorsement thereof. Use of such information may require a license from a third party under the patents or other intellectual property of the third party, or a license from TI under the patents or other intellectual property of TI.

Reproduction of information in TI data books or data sheets is permissible only if reproduction is without alteration and is accompanied by all associated warranties, conditions, limitations, and notices. Reproduction of this information with alteration is an unfair and deceptive business practice. TI is not responsible or liable for such altered documentation.

Resale of TI products or services with statements different from or beyond the parameters stated by TI for that product or service voids all express and any implied warranties for the associated TI product or service and is an unfair and deceptive business practice. TI is not responsible or liable for any such statements.

Following are URLs where you can obtain information on other Texas Instruments products and application solutions:

Products		Applications	
Amplifiers	amplifier.ti.com	Audio	www.ti.com/audio
Data Converters	dataconverter.ti.com	Automotive	www.ti.com/automotive
DSP	dsp.ti.com	Broadband	www.ti.com/broadband
Interface	interface.ti.com	Digital Control	www.ti.com/digitalcontrol
Logic	logic.ti.com	Military	www.ti.com/military
Power Mgmt	power.ti.com	Optical Networking	www.ti.com/opticalnetwork
Microcontrollers	microcontroller.ti.com	Security	www.ti.com/security
		Telephony	www.ti.com/telephony
		Video & Imaging	www.ti.com/video
		Wireless	www.ti.com/wireless

Mailing Address: Texas Instruments
Post Office Box 655303 Dallas, Texas 75265

Copyright © 2006, Texas Instruments Incorporated